

1129 100x22 mm

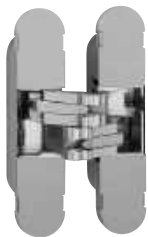

Patented

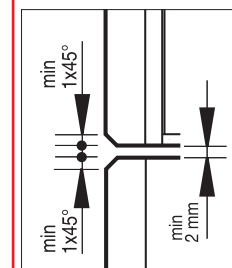
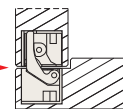
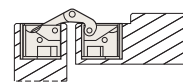
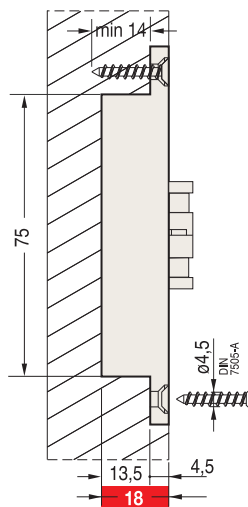
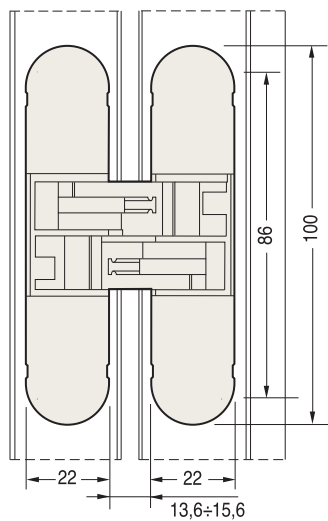

Mortise dimensions

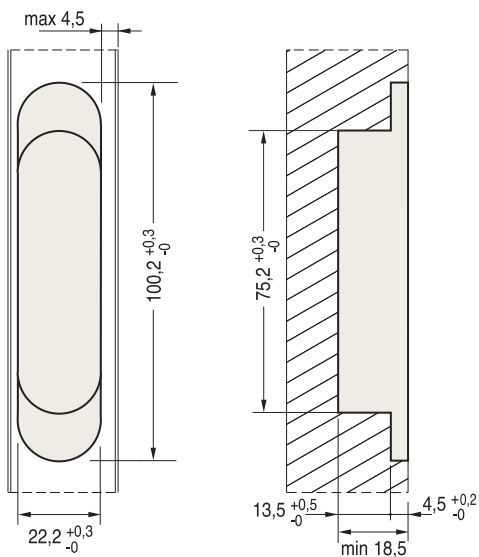

Cross section

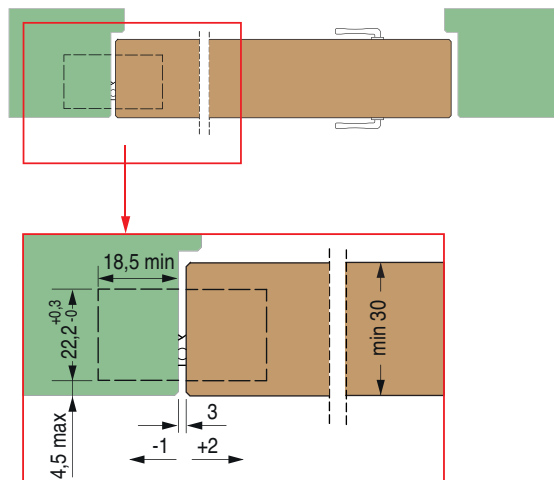

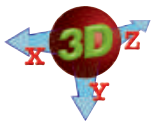

1129

100x22 mm

Load capacity

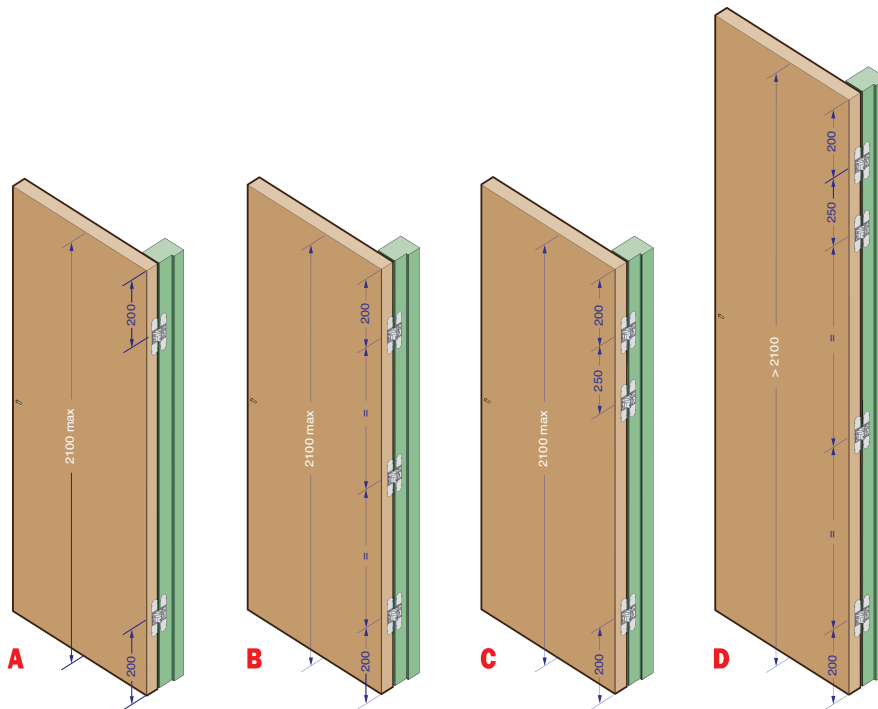

Wings
850 mm wide

- up to 2100 mm high
 - A - 2 hinges 25 kg
 - B - 3 hinges 30 kg
 - C - 3 hinges 40 kg

- over 2100 mm high
 - D - 4 hinges 40 kg

Before using a door closer, contact us

All hinges must be adjusted

Lubricate the hinges at least once a year

Installation

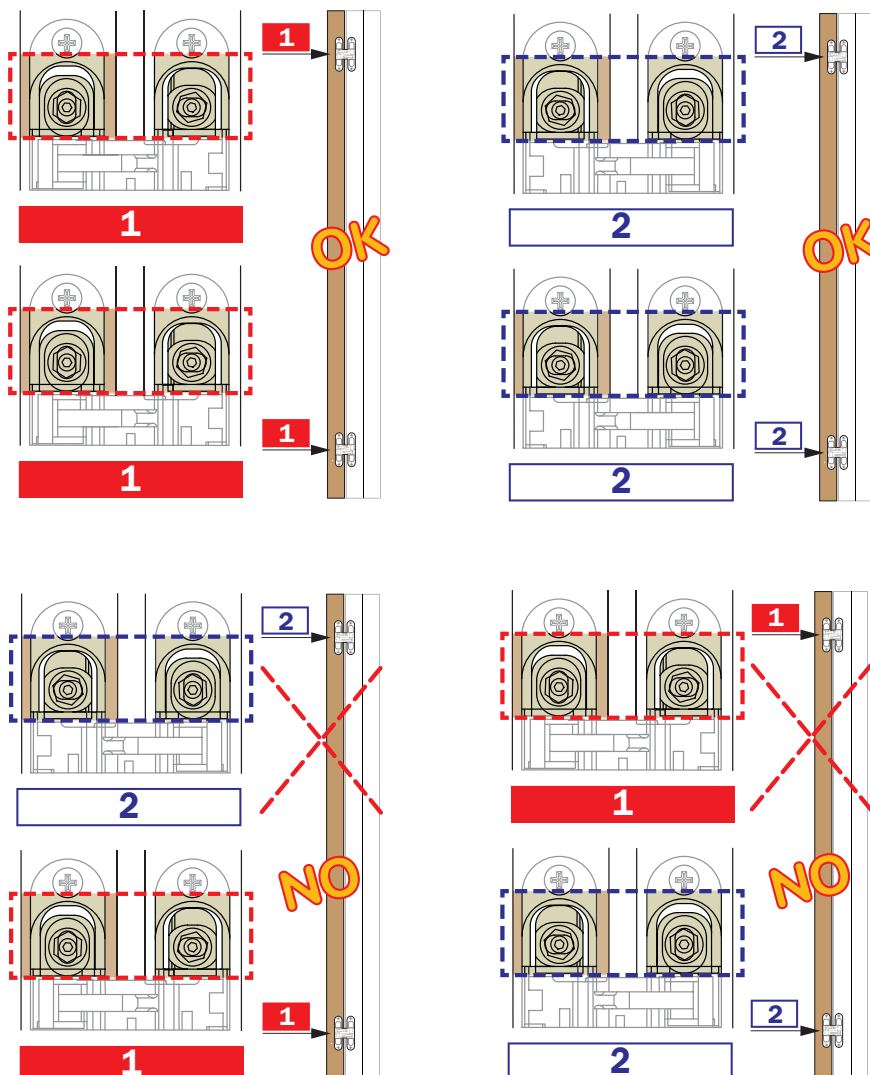

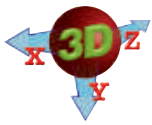

1129 100x22 mm

Vertical adjustment

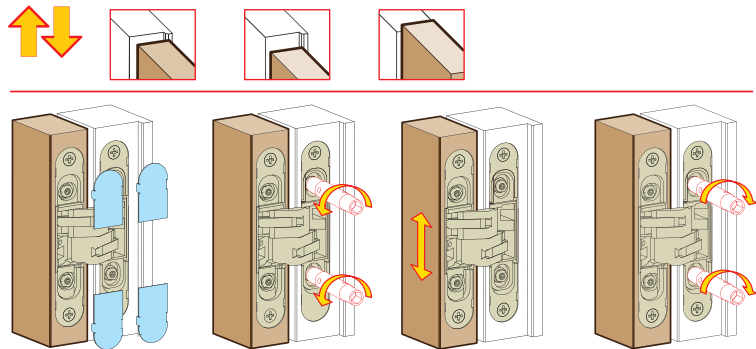
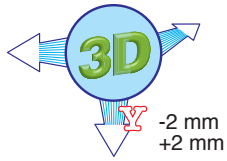

Horizontal adjustment

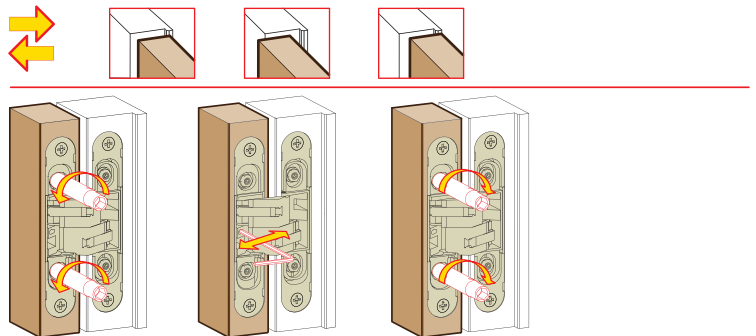
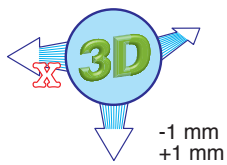

Depth adjustment

